

## FCC STATEMENT

---

This device complies with Part 15 of the FCC Rules. Operation is subject to the following two conditions:

- (1) This device may not cause harmful interference, and
- (2) This device must accept any interference received, including interference that may cause undesired operation.

### **Note:**

This equipment has been tested and found to comply with the limits for Class B digital devices, pursuant to Part 15 of the FCC rules. These limits are designed to provide reasonable protection against harmful interference in a residential installation. This equipment generates, uses and can radiate radio frequency energy and, if not installed and used in accordance with the instructions, may cause harmful interference to radio communications. However, there is no guarantee that interference will not occur in a particular installation. If this equipment does cause harmful interference to radio or television reception, which can be determined by turning the equipment off and on, the user is encouraged to try to correct the interference by one or more of the following measures:

- Reorient or relocate the receiving antenna
- Increase the separation between the equipment and receiver
- Connect the equipment into an outlet on a circuit different from that to which the receiver is connected
- Consult the dealer or an experienced radio/TV technician for help

Use of shielded cable is required to comply with Class B limits in Subpart B of Part 15 of the FCC rules.

Do not make any changes or modifications to the equipment unless otherwise specified in the manual. If such changes or modifications should be made, you could be required to stop operation of the equipment.

## TRADEMARK INFORMATION

---

- Microsoft® and Windows® are U.S. registered trademarks of Microsoft Corporation.
- Pentium® is a registered trademark of Intel Corporation.
- Macintosh is a trademark of Apple Computer, Inc.
- SD™ is a trademark.
- Other names and products may be trademarks or registered trademarks of their respective owners.

## WARNINGS

---

- Do not use the camera if it is emitting smoke, unusual odor or noise, becoming unusually hot to be touched, or if it is in any other abnormal state. Operating the camera in any of these circumstances may cause a fire or an electrical shock. Stop using the camera immediately, turn the camera off, and then disconnect the power source. After checking that smoke is no longer being emitted, contact to your dealer or a local authorized service facility for repairs. Never attempt to repair this camera by yourself, as this is dangerous.

---

- Do not use the camera if any foreign objects have entered the camera. Turn the camera off and then disconnect the power source. Later on contact to your dealer or a local authorized service facility. Do not continue to use the camera as this may cause a fire or an electrical shock.

---

- Do not place the camera in any unstable locations such as on a wobbly table or slopping surface where the camera may fall or tip over and cause damage.

---

- If the camera has been dropped or if the camera case has been damaged, turn the camera off and then disconnect the power source . Then contact to your dealer or a local authorized service facility. Do not continue to use the camera as this may cause a fire or an electrical shock.

---

- Do not expose the camera to the moisture and avoid water gets into the camera. Take particular care when using the camera under extreme weather conditions such as rain or snow, or when operating the camera at the beach or near water. Water in the camera may cause a fire or an electrical shock.

---

- Do not attempt to modify the camera. This may cause a fire or an electrical shock.

---

- Do not remove the camera casing. This may cause an electrical shock. Internal inspection, maintenance and repairs should only be carried out by your dealer or a local authorized service facility.

---

## CAUTIONS

---

- Do not place the camera in damp or dusty locations. This may cause a fire or an electrical shock.

---
- Do not place the camera in a location affected by oil fumes or steam, such as near a cooking stove or humidifier. This may cause a fire or an electrical shock.

---
- Do not cover or wrap the camera with a cloth or quilt. This may cause heat to build up, distort the case and cause a fire. Always use the camera and its accessories in well-ventilated locations.

---
- Handle the camera carefully and do not bump the camera into any hard object. Handling the camera roughly may cause a malfunction.

---
- When leaving the camera unused for long periods, such as during a vacation, always unplug the camera from the power source for safety. Failure to do so could result in a fire.

---
- Do not use battery other than those specified for use with the camera. The use of unsuitable battery may result in the battery splitting or leaking and causing a fire, injury, or soiling of the battery compartment.





---
- When fitting battery into the camera, check the polarity markings on the battery (- and +) to ensure that you insert the battery correctly. Incorrect battery polarity may result in the battery splitting or leaking and causing a fire, injury, or soiling of the battery compartment.



---
- Remove the battery if the camera will not be used for an extended period of time. The battery may leak and cause a fire, injury or soiling of the battery compartment. If the battery leak, clean and wipe the battery compartment carefully and install new battery. Wash your hands carefully if you touch the battery fluid.

---

# CONTENTS

<b>INTRODUCTION</b> -----	9
Overview-----	9
Package Contents-----	10
Optional Accessories-----	10
<b>GETTING TO KNOW THE CAMERA</b> -----	11
Front View-----	11
Rear View-----	12
Mode Dial-----	13
Viewfinder LED Indicator-----	14
LCD Monitor Information-----	15
<b>GETTING STARTED</b> -----	17
Installing the Battery-----	17
Using an AC Power Adapter-----	18
Charging the Battery-----	19
Inserting an SD Memory Card-----	20
Attaching the Strap-----	21
<b>TAKING PHOTOGRAPHS</b> -----	22
<b>Photography in the Auto Capture Mode [ A ]</b> -----	22
Using the Viewfinder-----	22
Using the LCD Monitor-----	23
LCD Monitor Display (Capture Mode)-----	23
<b>Using the Optical Zoom</b> -----	24

<b>Using the Digital Zoom</b> -----	25
<b>Using the Self-timer</b> -----	26
<b>Using the Flash</b> -----	27
<b>Changing the Focus</b> -----	29
<b>Changing the Exposure Compensation</b> -----	30
<b>Setting the Image Size and Quality</b> -----	32
<b>Photography in the Program Mode [ P ]</b> -----	34
<b>Photography in the Shutter Speed-priority Mode [ Tv ]</b> -----	34
<b>Photography in the Aperture-priority Mode [ Av ]</b> -----	35
<b>Photography in the Full Manual Mode [ M ]</b> -----	36
<b>Photography in the Portrait Mode [  ]</b> -----	36
<b>Photography in the Sports Mode [  ]</b> -----	37
<b>Photography in the Night Scene Mode [  ]</b> -----	37
<b>Making Movies [  ]</b> -----	38
<b>CHANGING THE PRESET CONDITIONS (IN CAPTURE MODE)</b> -----	39
<b>Picture setting</b> -----	40
Size-----	40
Quality-----	40
Sharpness-----	41
Contrast-----	41
Color-----	41
<b>Function setting</b> -----	42
Capture Mode-----	42
Voice Memo-----	42
LCD Brightness-----	43
Digital Zoom-----	43
Preview-----	43

Interval /Count-----	44
<b>AE/AWB setting</b> -----	<b>44</b>
White Balance-----	44
Metering-----	45
ISO-----	46
Manual WB-----	46
<b>PLAYING BACK IMAGES [  ]</b> -----	<b>47</b>
<b>Playing Back Photographed images</b>	
<b>(Single-Frame Playback)</b> -----	<b>47</b>
Voice Record-----	48
<b>Playing Back Movies</b> -----	<b>49</b>
Thumbnail Display-----	51
Zoom Playback-----	52
Slideshow Display-----	53
DPOF (Digital Print Order Format) -----	54
Protect-----	55
LCD Brightness-----	56
LCD Monitor Display (Playback Mode)-----	56
<b>ERASING IMAGES [  ]</b> -----	<b>57</b>
Erasing Single Image-----	57
Erasing All Images-----	57
Erasing Selected Image-----	58

<b>SET-UP MODE</b> .....	59
<b>Basic Setting</b> .....	59
Card Information.....	59
Frame Number Reset.....	60
Format.....	60
Sound.....	61
Beep.....	61
Auto Power Off.....	62
<b>Custom Setting</b> .....	63
Date/Time.....	63
System Reset.....	63
Language.....	64
Video Output.....	64
System Information.....	65
<b>TRANSFERRING RECORDED IMAGES/MOVIES TO YOUR COMPUTER</b> .....	66
<b>Step 1: Installing the USB Driver</b> .....	67
<b>Step 2: Connecting the Camera to Your Computer</b> .....	67
<b>Step 3: Downloading Images/Movies</b> .....	67
<b>INSTALLING PHOTOSUITE</b> .....	69
<b>INSTALLING PHOTOVISTA</b> .....	70
<b>CONNECTING THE CAMERA TO OTHER DEVICES</b> .....	71
<b>CAMERA SPECIFICATIONS</b> .....	72



# INTRODUCTION

---

## Overview

---

Your new digital camera delivers high quality, 2560 x 1920 resolution images using a 5.25 Megapixels CCD imager. Using either the optical viewfinder or the 1.5" TFT color image LCD monitor, you can compose images and then examine them in detail. An auto-flash sensor automatically detects the shooting (lighting) conditions and determines whether the flash should be used. This feature helps ensure that your images turn out right.

SD Memory Card is a storage medium for saving images that you have photographed. Even if the camera's power is turned OFF, the images saved on the SD Memory Card are not erased. SD Memory Card can be repeated read and written.

Images you have taken can be downloaded to your computer using the USB cable (USB driver required for Win 98 and Mac OS 8.6). You can enhance and retouch your images on your computer by using the provided editing software, or image editing software you may have already owned. You may share your images with your friends via e-mail, in a report, or on a website.

DPOF functionality allows you to print your images on a DPOF compatible printer by simply inserting the memory card.

### **Note:**

- The memory card testing results for 512MB are based on Toshiba, Panasonic and Sandisk SD Memory Card.

## Package Contents

---

Carefully unpack your camera and ensure that you have the following items. In the event that any item is missing or if you find any mismatch or damage, promptly contact to your dealer.

- 1xTraveler DC-5300 digital camera
- 1xTraveler pouch
- 1xTraveler 128MB SD card
- 1xTraveler rechargeable Li-ion battery-pack
- 1xTraveler AC-Mains Adapter/Charger
- 1xCamera strap
- 1xUSB cable
- 1xTV cable/Video cable
- 1xTraveler DC-5300 instruction manual

# GETTING TO KNOW THE CAMERA

## Front View

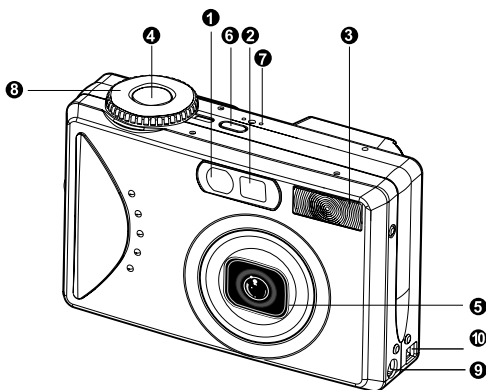

1. Self-timer/AF support LED
2. Optical viewfinder
3. Built-in flash
4. Shutter button
5. Lens/lens cover
6. **POWER** Power button
7. **MIC** Microphone
8. Mode dial
9. DC IN 5V terminal
10. USB/A/V OUT terminal

## Rear View

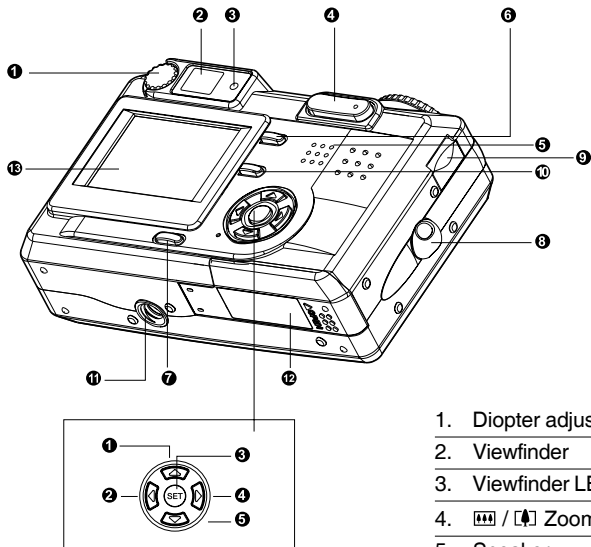





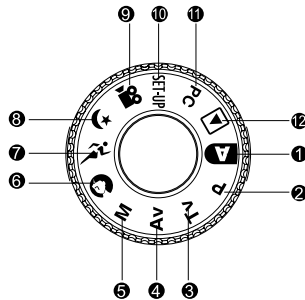

- |        |                            |
|--------|----------------------------|
| 1. ▲   | Arrow button (up)          |
| ⬇/▲    | Focus button/macro         |
| 2. ◀   | Arrow button (left)        |
| ☑/☒    | Exp./back light            |
| 3. SET | Set button                 |
| 4. ▶   | Arrow button (right)       |
| ⚡/☑    | Flash button               |
| 5. ▼   | Arrow button (down)        |
| ⌚/INT. | Self-timer button/interval |

- |                                   |
|-----------------------------------|
| 1. Diopter adjustment dial        |
| 2. Viewfinder                     |
| 3. Viewfinder LED                 |
| 4.  /  Zoom button                |
| 5. Speaker                        |
| 6. MENU Menu button               |
| 7.  Display button                |
| 8. Strap attachment               |
| 9. Command dial                   |
| 10.  Delete button                |
| 11. Tripod socket                 |
| 12. Battery/ SD Memory Card cover |
| 13. LCD monitor                   |

## Mode Dial

---



- |  |                             |   |                  |
|--|-----------------------------|---|------------------|
| 1. <b>A</b>  | Auto mode                   | 7.   | Sports mode      |
| 2. <b>P</b>  | Program mode                | 8.   | Night scene mode |
| 3. <b>Tv</b>   | Tv (Shutter Speed priority) | 9.   | Movie mode       |
| 4. <b>Av</b>   | Av (Aperture priority)      | 10. <b>SET-UP</b>   | Set-up mode      |
| 5. <b>M</b>  | Manual mode                 | 11. <b>PC</b>   | PC mode          |
| 6.  | Portrait mode               | 12.  | Playback mode    |

## Viewfinder LED Indicator

Color	State	Description			
		Photography Mode	Setup Mode Charge Mode	PC Mode	Battery
Green	On	AE or AF is locked with the Shutter button held half down.	In standby mode.	In communication to PC. (SD Memory Card is inserted.)	Under charging
Red	On	Writing to SD Memory Card in progress.	Accessing of SD Memory Card in progress	In connecting to PC. (SD Memory Card is inserted.)	Error
	Flashing	When the image is not in focus.	—	—	Interval timer standing by
Orange	On	Processing images Charging of flash in progress	—	Disconnection (SD Memory Card is inserted.)	No battery
	Flashing	Hardware malfunction		SD Memory Card is not inserted.	—

## LCD Monitor Information

### AUTO capture mode

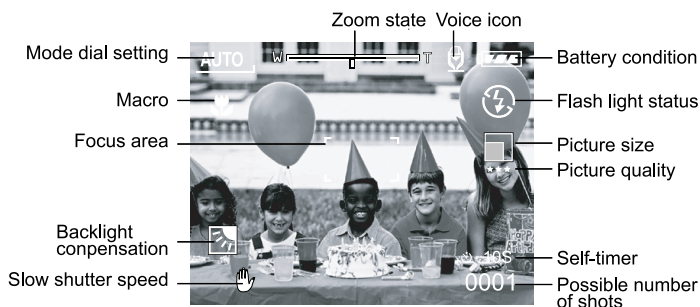

### Program/Tv/Av/Manual/Portrait/Sports/Night scene mode

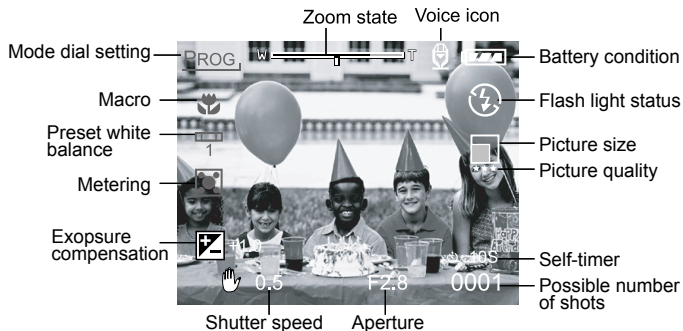

## Movie mode

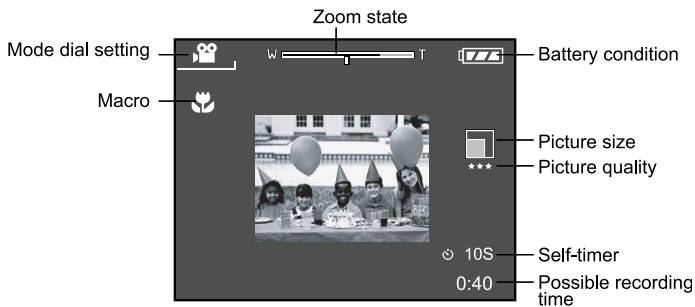

## Playback mode (Standard)

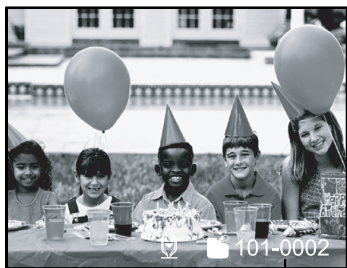

Folder number

## Playback mode (Detailed information)

File Name	:PICT0029.JPG
Size	:640X480
Quality	:Fine
Shutter speed	:1/80
Aperture	:3.5
ISO	:100
Strobe	:ON
File Size	:72kBytes



## GETTING STARTED

You can use either a Lithium Ion battery or an AC power adapter (5 V) to power on the camera. Battery power is convenient for capturing images or video clips while an AC adapter power is useful when transferring images to your computer.

### Installing the Battery

1. Make sure the camera power is off.
2. Open the battery/SD Memory Card cover.
3. Insert the battery in the correct orientation shown.

- Tilt the battery lock lever toward the strap attachment and then insert the battery following the orientation of the arrow on the battery's label.

- Insert the battery as far as it can go.

4. Close the battery/SD Memory Card cover.

- To remove the battery:

Open the battery/SD Memory Card cover and then release the battery lock lever. After the battery is slightly ejected, pull out the battery slowly.

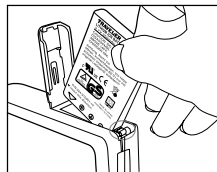

Battery lock lever

#### Note:

- Use only the specified battery type (Lithium Ion).
- If you are not going to use the battery for an extended period of time, remove it from the camera to prevent leakage or corrosion.
- Avoid using battery in extremely cold environments as low temperatures can shorten the battery life and reduce the camera performance.
- If you open the battery cover without removing the battery, the power will not be quit. If you remove the battery, you have to insert the battery again in a period of 2 hours in order to make sure that the date and time will not be reset.

## Using an AC Power Adapter

---

1. Make sure the camera power is off.
2. Connect one end of the AC power adapter to the DC IN 5V terminal.
3. Connect the other end of the AC power adapter to a power outlet.

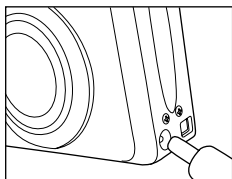

**Note:**

- Make sure to use only the AC power adapter specified for the camera. Damage caused by the use of an incorrect adapter is not covered under the warranty.
- Using an AC power adapter while transferring images to your computer in order to prevent unexpected automatic power off of the camera.

## Charging the Battery

---

1. Make sure the camera power is off.
2. Slide the battery/SD Memory Card cover into the direction of the [OPEN] arrow.
3. Insert the battery, noting correct polarity (+ and -).
4. Slide the battery lock lever to adjust the battery.
5. Close the battery/SD Memory Card cover firmly.
6. Connect one end of the AC power adapter to the DC IN 5V terminal.
7. Connect the other end of the AC power adapter to a power outlet.

Charging start: Green indicator

Charging end: Indicator off

Stand by: Orange indicator

Replace a new battery: Red indicator

### **Note:**

- Make sure to use only the AC power adapter specified for the camera. Damage caused by the use of an incorrect adapter is not covered under the warranty.
- When the charging is not started even if proceeding the operation above. Press power button on at any mode after LCD indication appears, then turn the power off.
- Never use the battery unspecified for the camera.
- Do not place the camera in hot temperature. Use it at room temperature.
- If you open the battery cover without removing the battery, the power will not be quit. If you remove the battery, you have to insert the battery again in a period of 2 hours in order to make sure that the date and time will not be reset.

## Inserting an SD Memory Card

All images and video clips taken by the camera can be stored in an SD (Secure Digital) Memory Card. Even if the camera's power is OFF, the images saved in the SD Memory Card are not erased. An SD Memory Card can be repeatedly read and written. You may also expand the memory capacity up to 512MB so that you can store additional images and video clips.

1. Make sure the camera is off.
2. Slide the battery/SD Memory Card cover in the direction of the [OPEN] arrow.
3. Insert an SD Memory Card :
  - The front side of the memory card (printed arrow) should face towards the front side of the camera.
  - If the card cannot be inserted, check the orientation.
4. Close the battery/SD Memory Card cover.
  - To remove the SD Memory Card, make sure the camera is off. Open the battery/SD Memory Card card cover. Press lightly on the edge of the memory card and it will eject.

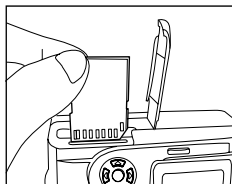

### Note:

- If the camera is powered-on without the card, the "NO CARD" message appears on the LCD monitor.
- To prevent valuable data from being accidentally erased from an SD Memory Card you can slide the write-protected tab (on the side of the SD Memory Card) to "LOCK".
- To save, edit or erase data on an SD Memory Card, you must unlock the card.
- MMC Card can not be accepted to use.
- Please format an SD Memory Card by this camera before use.
- If you open the battery cover without removing the battery, the power will not be quit. If you remove the battery, you have to insert the battery again in a period of 2 hours in order to make sure that the date and time will not be reset.

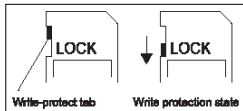

## Attaching the Strap

---

To prevent accidental slippage during the use, always use the strap.

Attach the hand strap as follows:

1. Thread the small loop of the hand strap through the strap eyelet on the camera.
2. Pull the large loop through the small loop until the strap is firmly secured.

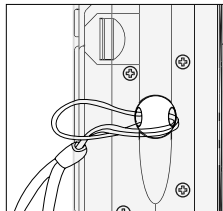

# TAKING PHOTOGRAPHS

## Photography in the Auto Capture Mode **A**

Your camera provides a single image capturing, continuous image capturing and auto exposure bracketing capturing. It is equipped with both an optical viewfinder and a 1.5" full color TFT LCD monitor to compose images. Taking images by using the optical viewfinder will conserve more battery power. If your battery is in low level, it is recommended to compose images by using the viewfinder. The LCD monitor can help you accurately compose the pictures and examine all details. However, this may also consume you more battery power.

### Using the Viewfinder

1. Turn the camera on by pressing the **POWER** button.
2. Set the mode dial to [ **A** ].
3. Compose your shot in the viewfinder.
  - Turn the "diopter adjustment dial" until the image appears clearly within the viewfinder.
4. Press the shutter button down halfway, then press it down fully.
  - The viewfinder LED indicator lights red while the camera is processing a captured image.

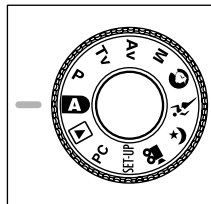

### Note:

- Voice memo is starting to record at still image capture mode just after the photograph is taken in case of activating this function. It provides 10 seconds for recording and only can be done once. To terminate recording, press the shutter button down fully.

Diopter adjustment dial

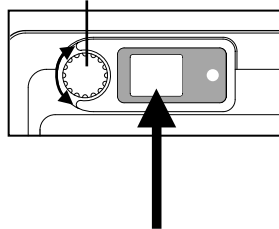

## Using the LCD Monitor

1. Turn the camera on by pressing the **POWER** button.
2. Set the mode dial to [ **A** ].
  - By default, the LCD monitor setting is "ON".
3. Compose the picture in the LCD monitor.
4. Press the shutter button down halfway (the camera adjusts the exposure and the focus), then press it down fully.
  - The viewfinder LED indicator lights red while the camera is processing a captured image.

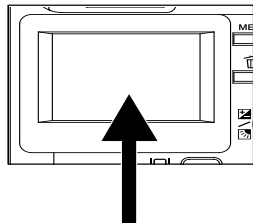

### Note:

- In still image capture mode, AF LED is activated at Auto and Macro mode when the LV value is under 6.

## LCD Monitor Display (Capture Mode)



The [  ] Display button can select display format. Whether in "Still Image" or "Movie" mode, preview image with full OSD is displayed.











OSD (on-screen-display) full display → OSD display OFF → LCD monitor OFF

### Note:

- The image in the LCD monitor darkens in strong sunlight or bright light. This is not a malfunction.
- Using the LCD monitor for an extended period of time will decrease the number of images you can take. To increase the shots and conserve battery power, it is recommended to turn the LCD monitor off and use the viewfinder instead.

## Using the Optical Zoom

The lens moves during the zoom photography. Zoom photography allows you to take telephoto and wide-angle shots. The subject appears closer by pressing the [  ] button and appears farther away by pressing the [  ] button.



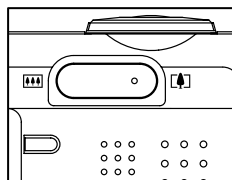

1. Set the mode dial to one of [  ], [ **P** ], [ **Tv** ], [ **Av** ], [ **M** ], [  ], [  ], [  ], [  ] and power on the camera.
2. If required, turn on the LCD monitor by pressing the [  ] button.
3. Compose the picture by using the [  ]/[  ] button.
  - Pressing the [  ] button zooms in on the subject, and enlarges the subject on the LCD monitor.
  - Pressing the [  ] button provides a wider angle picture. The lens position moves according to the zoom button setting.
4. Press the shutter button down halfway, then press it down fully.





## Using the Digital Zoom

By using the digital zoom, images can be enlarged so that the subject appears closer. However, the more the image is enlarged, the grainier the image will become. The digital zoom function is only available when you set the LCD monitor and the digital zoom to ON. To capture a digitally zoomed image, perform the following steps:

1. Set the mode dial to one of [ **A** ], [ **P** ], [ **Tv** ], [ **Av** ], [ **M** ], [  ], [  ], [  ] and power on the camera.
2. If required, turn on the LCD monitor by pressing the [  ] button.
3. To enable the digital zoom is as follows:
  - a. Press the **MENU** button.
  - b. Press the ◀ or ▶ button to select **Function** page.
  - c. Press the ▲ or ▼ button to select **Digital Zoom**, and press the **SET** button.
  - d. Press the ▲ or ▼ button again to select **ON**, and press the **SET** button.
  - e. Press the **MENU** button.
  - f. To activate the digital zoom, press the [  ] button completely and hold it until the image on the **LCD** monitor expands.
4. Press the shutter button to capture a “zoomed” image.

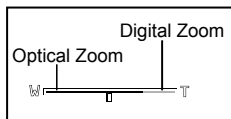

### Note:

- The camera has 1X to 3X optical zoom and 1X to 4.0X electrical zoom function.
- Digital zoom function is terminated when user selects LCD off mode.

## Using the Self-timer

The [  /INT. ] self-timer button can select the capturing mode between “OFF” (default) and “Self timer (2 sec., 10 sec., 10+2 sec. or Interval)”.

[2 sec.] The camera automatically takes a picture after two seconds delay.







[10 sec.] The camera automatically takes a picture after ten seconds delay.

[10+2 sec.] The camera automatically takes a picture after ten seconds delay, and takes again after two seconds.

In case of flash light capacitor is not charged up, the second take can be done at two second after charged.

[Interval] The camera automatically takes a picture every preset time till media full or battery empty.

To activate the self-timer by pressing the shutter button. After selecting this mode, self-timer icon displays on **LCD** monitor and then LED on the front panel blinks fast for the last 3 seconds. Using the self-timer allows you to get into the scene when taking group images.

1. Secure the camera to a tripod or place it on a stable surface.
2. Set the mode dial to one of [  ], [ **P** ], [ **Tv** ], [ **Av** ], [ **M** ], [  ], [  ], [  ], [  ] and power on the camera .
3. Press the [  /INT. ] button.

- When you toggle the self-timer button, the following are displayed in the accordingly order:

Off → 10 sec → 2sec → 10+2sec → Interval

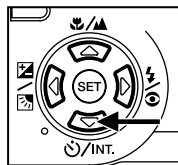
4. Compose the picture.
5. Press the shutter button down halfway, then press it down fully.
  - The self-timer function is activated. The photograph is then taken after the preset time.
  - When the photographs are taken using the LCD monitor, the count down is displayed.

**Note:**







- After an image is taken using self-timer, the self-timer mode is turned off.
- The self-timer is not possible in the continuous capture mode.
- The self-timer is only available for 2 or 10 seconds delay at [  ] mode. The camera automatically starts to recording after 2 or 10 seconds.

## Using the Flash

---

The flash is designed to function automatically when lighting conditions warrant the use of flash. You can take an image using a suitable flash mode to your circumstances.

If you change the flash mode, the camera will retain that setting even if the camera is turned off.

1. Set the mode dial to one of [  ], [  ], [  ], [  ], [  ] and power on the camera.
2. Press the [  ] button repeatedly until your desired flash mode appears.
  - When you toggle the flash button at [  ] mode, the available flash modes are displayed in the following order.

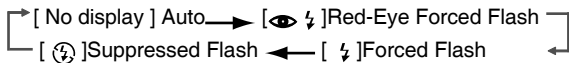
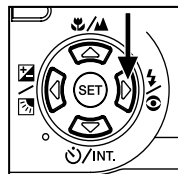



3. Compose the picture and press the shutter button down halfway, then press it down fully.

**Note:**







- After flash fires, it takes approximately 5 seconds to 10 seconds to be ready for the next shot during solid orange indicator.

The camera has FOUR flash modes: Auto, Red-Eye Reduction, Forced Flash and Flash Off.







The table below will help you to choose the appropriate flash mode:

Icon	Flash Mode	Description
[ ]	Auto Flash	The flash fires automatically according to the ambient lighting conditions.
[  ]	Red-Eye Reduction (With auto-flash except to [Tv] [Av],[M])	Select this mode for general photography. The flash emits a precursor-flash before the main flash fires. This causes the pupil in the human eyes to contract, reducing the red-eye phenomenon. Select this mode when taking images of people and animals in low-light conditions.
[  ]	Forced Flash	The flash will always fire regardless of the surrounding brightness. Select this mode for recording images with high contrast (back lighting) and deep shadows.
[  ]	Flash Off	The flash will not fire. Select this mode when taking images in a place where flash photography is prohibited, or when the distance to the subject is beyond the effective range of the flash.

**Note:**

- Auto flash can only be set at [  ] mode. It can not be set at [M], [P], [Tv] and [Av] modes.
- In the [  ] Portrait mode, flash setting is fixed to Red-Eye Reduction mode automatically.
- In the [  ] Sports mode, flash setting is fixed to [  ].
- In the [  ] Night scene mode, flash setting is fixed to [  ] except [  ] Focus mode

## Changing the Focus

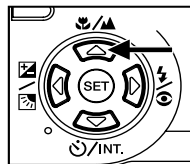

- Set the mode dial to one of [ **A** ], [ **P** ], [ **Tv** ], [ **Av** ], [ **M** ], [  ], [  ], [ **C\*** ], [  ] and power on the camera.
- Toggle the [  /  ] Focus button.  
The selected focus mode is displayed on the LCD monitor.
  - [no indication]: Normal Auto Focus (0.8m to infinity).
  - [  ]: Macro Auto Focus (0.09m to infinity/  
Wide, 0.3m to infinity/Tele).
  - [  ]: The camera will focus on the subjects  
in a distance of infinity to take photos.
  - [3m]: The camera will focus on subjects  
in a distance of 3m to take photos.
  - [1m]: The camera will focus on subjects in  
a distance of 1m to take photos.
- Compose the picture.
- Press the shutter down halfway, then press it down fully.









### Note:

- When shooting a close-up in Macro mode, use the LCD monitor to compose your shot, avoiding the off-center parallax phenomenon.
- There is not a distinct point (subject range) at which Normal mode is favored over Macro mode; take in image in both optical modes and compare the results.
- After a Macro shot is taken **DO NOT FORGET** to reset the lens to the normal position.

## Changing the Exposure Compensation

This setting [  /  ] allows you to intentionally lighten or darken the entire image. Use this setting when the optimum brightness (exposure) cannot be obtained, for example, when the brightness between the subject and the background is not balanced or when the subject to photograph occupies only an extremely small part of the screen.

The [  /  ] Exposure Compensation button can select “Normal capturing mode”, “Backlight compensation capturing mode” and “Exposure compensation adjusting mode” cycling.

1. Set the mode dial to one of [P], [Tv], [Av] and power on the camera.
2. Toggle the [  /  ] button to select exposure compensation mode or backlight compensation mode.
3. When exposure compensation mode is selected, rotate the **Command** dial to adjust the exposure, and press the [  /  ] button again to confirm.
  - Rotate the **Command** dial to counter clockwise direction to decrease (darken) exposure, and rotate the **Command** dial to clockwise direction to increase (brighten) exposure.
4. Compose the picture, press the shutter button down halfway, and press it down fully.



Backlight compensation



Exposure compensation

## Effective Subjects and Set Values

- Positive (+) Compensation
  - Copying of printed text (black characters on white paper)
  - Backlit portraits
  - Very bright scenes (such as snowfields) and highly reflective subjects
  - Shots made up predominantly of sky
- Negative (-) Compensation
  - Spotlit subjects, particularly against dark backgrounds
  - Copying of printed text (white characters on black paper)
  - Scenes with low reflectivity, such as shots of green or dark foliage

### Note:

- While selecting "Backlight compensation capturing mode", the EV value sets to +1.3 EV automatically and setting of exposure compensation value is ignored.
- In "Exposure compensation", the default value is "0.0EV". The setting range is as follows:  
-2.0 / -1.7 / -1.3 / -1.0 / -0.7 / -0.3 / 0 (default) / +0.3 / +0.7 / +1.0 / +1.3 / +1.7 / +2.0
- Exposure Compensation cannot be set at [ **A** ] mode.
- The ideal brightness sometimes cannot be obtained even if a large exposure value is set in dark photographic conditions.  
In this case, press the shutter button, and check the brightness in the preview image (photographed still image).



## Setting the Image Size and Quality

---

Size and quality settings determine the pixel size (dimension), image file size, and compression ratio for your image. These settings affect the number of images. These settings affect the number of images that can be stored in an SD Memory Card.

Larger and higher quality images offer the best photographic results but take up more memory space. Larger/quality settings are recommended for printed output and situations requiring the finest detail. Smaller/quality images take up less memory space and may be quite suitable for sharing images via e-mail, in a report, or on a web page.

To change image size or image quality,

1. Set the mode dial to one of [ **A** ], [ **P** ], [ **Tv** ], [ **Av** ], [ **M** ], [  ], [  ], [  ] and power on the camera.
2. Press the **MENU** button.
  - The menu screen appears.
3. Select Size or Quality by using the **▲** or **▼** button.
4. Press the **SET** button. Select the desired image size or image quality setting by using the **▲** or **▼** button.
5. Press the **SET** button to confirm. To exit the menu screen press the **MENU** button.



The tables below show the approximate number of images that can be stored on Still Image and Movie Image mode.

### Still Image Mode (pcs)

Image Size	Image Quality	64MB	128MB	256MB	512MB
2560*1920	Fine	26	54	105	222
	Standard	45	91	177	374
	Economic	84	170	331	698
2048*1536	Fine	45	91	177	374
	Standard	73	147	286	604
	Economic	146	295	573	1208
1280*960	Fine	84	170	331	698
	Standard	146	295	573	1208
	Economic	253	512	994	2094
640*480	Fine	292	590	1147	2417
	Standard	422	853	1657	3491
	Economic	761	1536	2984	6284

(For reference only)

### Movie Image Mode (sec)

Image size	Image Quality	Recording time
320*240	Fine	30
	Standard	45
	Economic	60
160*120	Fine	90
	Standard	120
	Economic	180

(For reference only)

- \* The above data shows the standard testing results. The actual capacity varies according to the shooting conditions and settings.

## Photography in the Program Mode[P]

The camera automatically adjusts the shutter speed and the aperture value according to the brightness of an object. It is possible to change the white balance, the metering system and exposure compensation in program mode.

1. Set the mode dial to [P] and power on the camera.
2. Compose the picture.
3. Press the shutter button down halfway, and press it down fully.

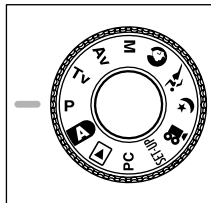

## Photography in the Shutter Speed-priority Mode[Tv]

In this mode, photographs are taken with the priority given to shutter speed. The camera automatically sets the aperture value according to the shutter speed. A fast shutter speed produces a photograph that looks as if a moving subject is still. A slow shutter speed produces as photograph that makes you feel that it is flowing.

1. Set the mode dial to [Tv] and power on the camera.
2. Rotate the **Command** dial to adjust the shutter speed.
3. Compose the picture and press the shutter button down halfway, then press it down fully.

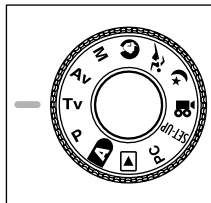

### Note:

- If the appropriate combination cannot be set even if the aperture is adjusted to its limit, the aperture value is displayed in "red".

## Photography in the Aperture-priority Mode [Av]

In this mode, photographs are taken with the priority given to aperture. The camera automatically sets the shutter speed according to the aperture.

A small aperture value produces a portrait photo with an out-of-focus background. The smaller the aperture value, the more out-of-focus the background becomes.

A large aperture value produces sharp images on both close objects and distant objects like landscapes. The larger the aperture value, the larger the area for sharp images.

1. Set the mode dial to [Av] and power on the camera.
2. Rotate the **Command** dial to adjust the aperture value.
  - The aperture value and the shutter speed corresponding to that value are displayed on the LCD monitor.
3. Compose the picture and press the shutter button down halfway, then press it down fully.

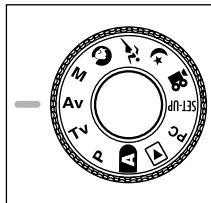



### Note:

- The larger the F value, the smaller the aperture size becomes and vice versa.

## Photography in the Full Manual Mode[M]

This mode can set the aperture and shutter speed values separately before taking a photograph. Both the aperture value and shutter speed can be changed by rotating the **Command** dial.

1. Set the mode dial to [M] and power on the camera.
2. Adjust the aperture and shutter speed separately.
  - Press the [  /  ] button to select the aperture or shutter speed. Available function is displayed in blue on the LCD monitor.
  - Rotate the **Command** dial to adjust the value.
3. Compose the picture, press the shutter button down halfway, and press it down fully.

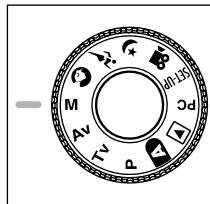

## Photography in the Portrait Mode [ ]

Select this mode to make people stand out with the background out-of-focus. Flash setting is fixed to red-eye reduction mode automatically.

1. Set the mode dial to [  ] and power on the camera.
2. Compose the picture.
3. Press the shutter button down halfway, and press it down fully.

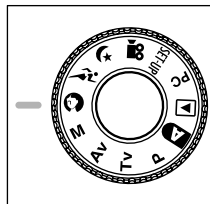

## Photography in the Sports Mode [ ]

Select this mode to take photographs of fast-moving subjects. Flash photography is not possible.

1. Set the mode dial to [  ] and power on the camera.
2. Compose the picture.
3. Press the shutter button down halfway, and press it down fully.

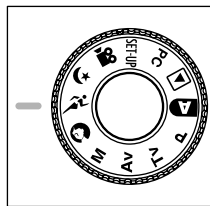

## Photography in the Night Scene Mode [ ]

Select this mode to take photographs of people against a dusk or night-time background. Flash setting is fixed to Slow Synchro (the flash is fired at a slower shutter speed).

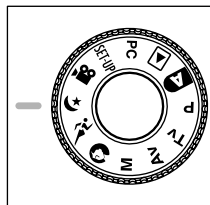

1. Set the mode dial to [  ] and power on the camera.
2. Compose the picture.
3. Press the shutter button down halfway, and press it down fully.



## Making Movies [ ]



---

The movie mode allows you to record video clips at the size of 320 x 240 pixels and 160 x 120 pixels.





By dialing the MODE switch to [  ] position, the camera can take moving image with "voice" recording. The camera shows the preview image on the LCD monitor. (In [  ] mode, the LCD monitor cannot be turned off.)





1. Set the mode dial to [  ].
2. Compose the picture, press the shutter button down halfway, and press it down fully.
  - Photography begins. [REC] appears on the LCD monitor.
3. To stop making movies, press the shutter button down fully again.
  - If you do not do this, photography is automatically stopped when there is no more free space on the SD Memory Card, or when the maximum size that a single movie can be recorded is reached.

### **Note:**

- In [  ] mode, EV compensation cannot be set or activated.
- In [  ] mode, the flash mode is automatically set to [OFF].
- The image size during capture and playback becomes (320X240) or (160x120).
- The movie made in (320x240) size is displayed on the entire LCD monitor, and that made in (160x120) size is displayed in the center of the screen.

## CHANGING THE PRESET CONDITIONS (IN CAPTURE MODE)

This menu is for setting the basic setting to be used for photography in the [ **A** ], [ **P** ], [ **Tv** ], [ **Av** ], [ **M** ], [  ], [  ], [  ] or [  ] photography modes.

1. Set the mode dial to one of [ **A** ], [ **P** ], [ **Tv** ], [ **Av** ], [ **M** ], [  ], [  ], [  ], [  ] and power on the camera.
2. Press the **MENU** button.
  - The menu screen is displayed.
3. Use the ◀ or ▶ button to select the menu page.
4. Use the ▲ or ▼ button to select the desired item and press the **SET** button.
  - The options are displayed.
5. Use the ▲ or ▼ button to select the desired setting and press the **SET** button.
  - This saves the settings, and returns the display to menu screen.
6. To exit the menu screen, press the **MENU** button.
  - The camera is now ready to take photographs.

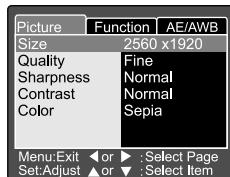

## Picture Setting

The Picture Setting contains 5 items: Size, Quality, Sharpness, Contrast and Color.

### Size

Set the desired image size.

**[2560 x 1920]:** 2560 x 1920 pixels

**[2048 x 1536]:** 2048 x 1536 pixels

**[1280 x 960]:** 1280 x 960 pixels

**[640 x 480]:** 640 x 480 pixels

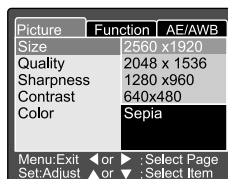

### Note:

- In the [  ] mode, image size available in this setting is 320 x 240 pixels and 160 x 120 pixels.

### Quality

Set the quality (compression ratio) sharpness at which the image is to be recorded.

**[Fine]:** 1/4compression(still image)/1/10  
compression(video clip)

**[Standard]:** 1/8 compression(still image)/1/14  
compression(video clip)

**[Economy]:** 1/16 compression(still image)/1/19  
compression(video clip)

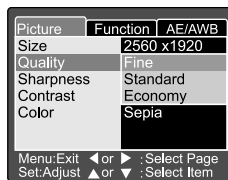



## Sharpness

Set the level of the image sharpness.

**[Hard]:** Hard effect

**[Normal]:** Normal sharpness (default)

**[Soft]:** Soft effect

### Note:

- This function is not available in the [  ] mode.

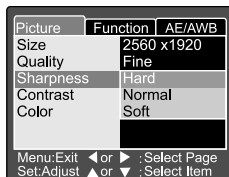

## Contrast

Set the contrast of the image to be photographed.

**[Hard]:** Hard contrast

**[Normal]:** Automatic (standard) setting(default)

**[Soft]:** Soft contrast

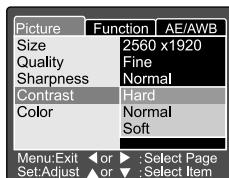

## Color

Set the color of the images to be photographed.

**[Standard]:** Standard color (default)

**[Vivid]:** Vivid color

**[Sepia]:** Sepia

**[Monochrome]:** Black and white

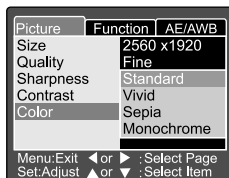

## Function Setting

The Function Setting contains 6 items: Capture Mode, Voice Memo, LCD Brightness, Digital Zoom, Preview and Interval/Count.

### Capture Mode

Set the capture mode at which the image is to be recorded.

**[Single]:** 1 shot mode can be set (default).

**[Continuous]:** In this mode, photographs are taken continuously at a maximum speed of 0.5 second speed interval. The maximum number of photographs that can be taken continuously is 3 photographs.

**[Auto Exp.]:** In this mode, the camera takes 3 consecutive pictures in the order of standard exposure, underexposure and overexposure compensation.

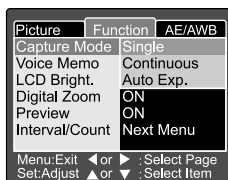

### Voice Memo

Set the voice memo for still image. In case of activating voice memo, audio data which incoming from microphone is recorded 10 seconds at preview or playback mode.

**[ON]:** Enable voice memo

**[OFF]:** Disable voice memo

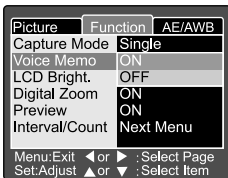

### Note:

- When voice memo is set to "ON", preview setting is also fixed to "ON".

## LCD Brightness

Adjust the brightness of the LCD monitor. By selecting LCD Bright. of menu, and press the **SET** button, the LCD control mode is displayed.

Press **▼** button to darken the LCD monitor, or **▲** button to lighten the LCD monitor.

The LCD monitor's adjustment range is within -5 to +5. The default value is 0.

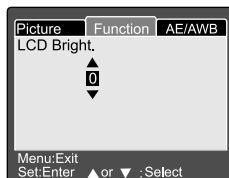

## Digital Zoom

Enlarge the center of the screen and takes photographs with the focal distance increased by factor of 4.0.

**[ON]:** Enable digital zoom photography (default).

**[OFF]:** Disable digital zoom photography.

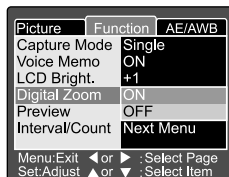

## Preview

Set to display a photographed image on the LCD monitor immediately after you have taken the shot.

**[ON]:** Enable display preview (default).

**[OFF]:** Disable display preview.

### Note:

- A photographed image is displayed on the LCD monitor for 2 seconds.
- When preview is set to "OFF", voice memo setting is also fixed to "OFF".

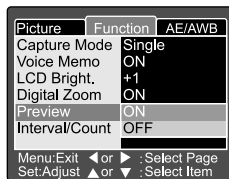

## Interval/Count

The camera provides interval image capturing based on this setting.

This mode is available in the self-timer photography.

By selecting Interval/Count and press the **SET** button, the Interval/Count mode is displayed.

Press the ▲ or ▼ button to change the interval time.

[1 Min.]: Recording interval is 1 minute

[3 Min.]: Recording interval is 3 minutes

[10 Min.]: Recording interval is 10 minutes.

[60 Min.]: Recording interval is 60 minutes.

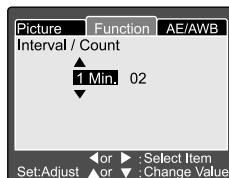

Select count by pressing the ◀ or ▶ button. You can set the counts you want to take pictures by pressing the ▲ or ▼ button. To cancel Interval/Count while this function is activated, press the power button to turn off or toggle the mode dial.



[2]: 2 shots can be taken

↵

[99]: 99 shots can be taken

## AE/AWB Setting

The AE/AWB Setting contains 4 items: White balance, Metering, ISO and Manual WB.

This menu is not available in the [  ]Auto and [  ]mode.

### White Balance

The camera determines the white balance by averaging the various kinds of light that actually enters the lens. You may set in advance the white balance when taking photographs under specific lighting conditions.

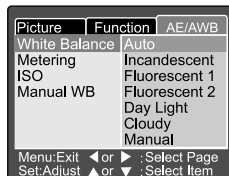

- [ **Auto** ] : Auto white balance (default).
- [ **Incandescent** ]: Incandescent light mode.
- [ **Fluorescent 1** ]: Reddish fluorescent light mode.
- [ **Fluorescent 2** ]: Bluish fluorescent light mode.
- [ **Day Light** ]: Daylight mode.
- [ **Cloudy** ]: Cloudy mode.
- [ **Manual** ]: Manual mode.

## Metering

The camera calculates the exposure level before a photograph is taken.

- [ **Multi** ]: Multi metering (default)

The exposure is measured and calculated for the entire area of the screen. By dividing the entire area of the screen, the exposure level for each unit is calculated. A well balance exposure can be obtained.

- [ **Spot** ]: Spot metering

The exposure is measured in a very small area at the center of the screen. It is possible to calculate the exposure of a subject without being affected by the surrounding environment.

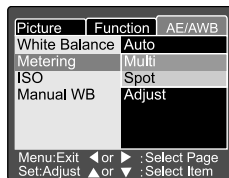

## ISO

Set the photographic sensitivity at which the image is to be recorded.

**[100]:** Equivalent to color ISO100.

**[200]:** High-sensitive photography equivalent to color ISO200.

**[400]:** High-sensitive photography equivalent to color ISO400.

**[Auto]:** Automatically set between ISO 100 to ISO 400.

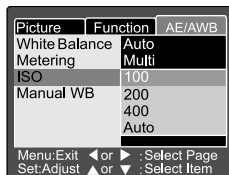

### Note:

- In [ **A** ], [ **Q** ], [ **W** ], [ **☆** ] or [ **W** ] mode, the ISO will be automatically set between ISO 100 to ISO 400.
- In [ **Tv** ], [ **Av** ] or [ **M** ] mode, during 100, the ISO will be fixed to ISO 100; during 200, the ISO will be fixed to ISO 200; during 400, the ISO will be fixed to ISO 400.
- In [ **P** ] mode, ISO setting has 100, 200, 400 and Auto . If Auto is selected, the camera will automatically set the ISO value according to the ambient brightness.

## Manual WB

You may select “Manual WB” by using **▲** or **▼** button at AE/AWB adjusting menu, and press the **SET** button. LCD monitor shows the manual WB menu. Compose the picture with white object (e.g.white paper) inside the area indicated by blue angle on the LCD monitor.

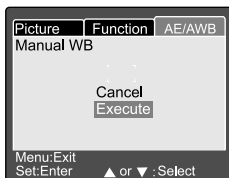

Select “Execute” by using the **▲** or **▼** button, then press the **SET** button.

### Note:

- This operation does not care the current mode of white balance. After setting manual WB automatically white balance mode can be set to manual.

## PLAYING BACK IMAGES [ ]

### Playing Back Photographed Images (Single-Frame Playback)

---

Play back photographed still images one image at a time.

1. Set the mode dial to [  ] and power on the camera.
  - The last recorded image appears on the LCD monitor.
2. Rotate the **COMMAND** dial or press the **▲** or **▼** button to advance to next frame or to go back one frame.
  - Rotate clockwise: Display the next image.
  - Rotate counterclockwise: Display the previous image.

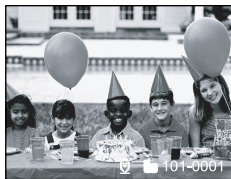

#### **Note:**

- Press the **SET** button to playback the voice memo data.
- Images can be rotated by pressing the **◀** or **▶** button during playback. Pressing the **◀** button rotates an image counterclockwise, and pressing the **▶** button rotates it clockwise.
- If no images in the SD Memory Card, the message of "NO IMAGE" is displayed on the LCD monitor.
- You can also playback your images on a TV screen. First connect one end of the A/V cable to the A/V out terminal of the camera. Then connect the other end to the A/V input socket of the TV. Set the mode dial to (playback) and then turn the TV and camera on.
- Make sure to turn off the camera before connecting or disconnecting with the A/V cable.

## Voice Record

---

By pressing the shutter button during playing back the picture, voice may be recorded. When pressing the shutter button down fully “VOICE RECORDING” is indicated on the LCD monitor for 10 seconds. Pressing the shutter button down fully again “VOICE RECORD END” is indicated.

**Note:**

- In the playback display mode, voice icon is displayed for the voice recorded picture.
- Voice record is also available at still image capture mode.
- Voice record only can be done once.



## Playing Back Movies

---

Playback movies that you have recorded. The movies made in **FULL** size are displayed on the entire LCD monitor, and those made in **HALF** size are displayed in the center of the screen.

1. Set the mode dial to [  ] and power on the camera.
  - The last recorded image appears on the LCD monitor.
2. Rotate the **Command** dial or press the **▲** or **▼** button to select the movie to play back.
3. Press the **SET** button.
  - Playback of the selected movie begins.

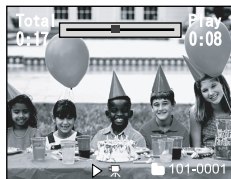



A user can control playback movie file as the following table:

	During playback	During pause	During playback 2x	During playback 4x	During reverse playback 2x	During reverse playback 4x	During stopping
▶ button	2x-speed playback	1-frame feed	4x-speed playback	Playback	2x-speed playback	2x-speed playback	-
◀ button	Reverse 2x-speed playback	Reverse 1-frame feed	Reverse 2x-speed playback	Reverse 2x-speed playback	Reverse 4x-speed playback	Playback	-
▲ button	pause	Canceling pause	Pause	Pause	Pause	Pause	Display backward picture (or Movie thumbnail)
▼ button	-	-	-	-	-	-	Display forward picture (or Movie thumbnail)
SET button	Stop(The display returns to the 1 <sup>st</sup> frame playback)	Stop(The display returns to the 1 <sup>st</sup> frame playback)	Stop(The display returns to the 1 <sup>st</sup> frame playback)	Stop(The display returns to the 1 <sup>st</sup> frame playback)	Stop(The display returns to the 1 <sup>st</sup> frame playback)	Stop(The display returns to the 1 <sup>st</sup> frame playback)	Playback
R Command dial	-	1-frame feed	-	-	-	-	Display forward picture (or Movie thumbnail)
L Command dial	-	Reverse 1-frame feed	-	-	-	-	Display backward picture (or Movie thumbnail)

## Thumbnail Display

---

This function allows you to view nine thumbnail images on the LCD monitor simultaneously so that you can quickly scan for a particular image.

1. Set the mode dial to [  ] and power on the camera.
  - The last image frame appears on the LCD monitor.
2. Press the [  ] button.
  - Nine images are displayed simultaneously.
3. Use the **▲**, **▼**, **◀** or **▶** button to move the cursor and select the image to be displayed at regular size.
4. Press the **SET** button to display the selected image on the full screen.















**Note:**

- In the thumbnail display mode, movie icon [  ] is displayed for the movie data.

## Zoom Playback



The camera has 2x and 4x playback digital zoom function. While reviewing your images, you may enlarge a selected portion of an image. This magnification allows you to view fine details.

Movies cannot be displayed using the zoom playback feature.

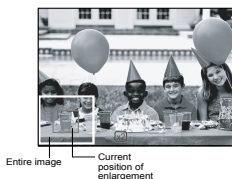
- Set the mode dial to [  ] and power on the camera.
  - The last image frame appears on the LCD monitor.
- Rotate the **COMMAND** dial or press the  or  button to select the frame you want to enlarge.
  - You can also select the image by the same operation as for thumbnail playback.
- Adjust the zoom ratio by using the [  ] or [  ] button.
  - Pressing the [  ] button will enlarge the image.
  - To return to normal magnification, press the [  ] button
  - The image is displayed enlarged, and a white frame and green frame are displayed on the LCD monitor.
  - The white frame indicates the entire image, while the green frame shows the location of the currently enlarged area.
- Use the , ,  or  button to select the area to enlarge.
  - Adjust the display area to enlarge while viewing the white and green frames.
- To return to the regular display, press the [  ] button.





### Note:

- Pressing the [  ] button magnifies the image from 1x→2x→4x.
- Pressing the [  ] button reduces the image from 4x→2x→1x.

## Slideshow Display

---

The slideshow function enables you to playback your images automatically in sequential order as a slide show. This is a very useful and entertaining feature for reviewing recorded images and for presentation.

1. Set the mode dial to [  ] and power on the camera.
  - The last image frame appears on the **LCD** monitor.
2. Press the **MENU** button.
  - The menu screen appears.
3. Select Slide Show by using the ▲ or ▼ button.
4. Press the **SET** button.
  - The slideshow starts at 3 seconds interval and [  ] is displayed on the **LCD** monitor.
  - To stop the slideshow display, press the **SET** button.

### **Note :**

- The Auto Power Off function does not operate during the slide show.

## DPOF (Digital Print Order Format)

### Print Information

DPOF is the abbreviation for Digital Print Order Format, which allows you to print the images directly from the DPOF-compatible printers by simply inserting the memory card into the printer and do the necessary settings.

1. Set the mode dial to [  ] and power on the camera.

2. Press the **MENU** button.

■ The menu screen appears.

3. Select the “DPOF” by using the **▲** or **▼** button and press the **SET** button.

■ You can select the Single or All option and press the **SET** button to confirm the selection.

4. Print Number, Date and Print Enable appear. Use the **▲** or **▼** button to select one of them and press the **SET** button to confirm.

5. Use the **▲**, **▼**, **◀** or **▶** button to make change and press the **SET** button to confirm.

■ The camera returns to Single/All submenu.

To exit from the menu screen, press the **MENU** button.

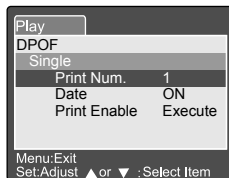

**[Print Number]** : Select the image quantity from 1-9.





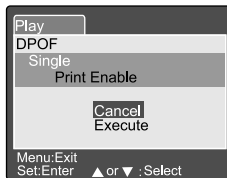
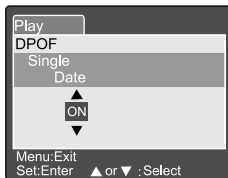
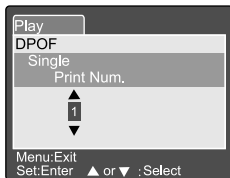



**[Date]** : Select to print the date on the image or not.

**[Print Enable]** : If you select “Cancel” and press the **SET** button to confirm, all the settings will be deleted. If “Execute” is selected and confirmed the camera will save the settings.







## Protect

This function gives the image protection from erasing. Follow the steps below to perform the protect functions.

- Set the mode dial to [  ] and power on the camera.
- Press the **MENU** button.
  - The menu screen appears.
- Select the Protect by using the  or  button and press the **SET** button.
- Protect submenu appears, including Single, All and Select. Use the  or  button to select one of them and press the **SET** button to confirm.
- Use the  or  button to select the desired setting and press the **SET** button.
  - In Single/All submenu, use the  or  button to select the desired setting and press the **SET** button.
 

**[Set]:** The one image displayed on the LCD monitor is locked and [  ] is displayed on the LCD monitor.

**[Cancel Protect]:** Cancel image protection.

**[Exit]:** Exit from the menu screen.
  - If "Select" is selected, thumbnail display appears on the LCD monitor. Use the , ,  or  button to select the image and press the [  ] button to select lock/unlock and press the **SET** button to confirm.

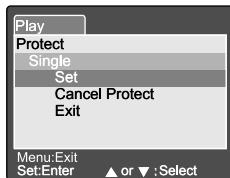

## LCD Brightness

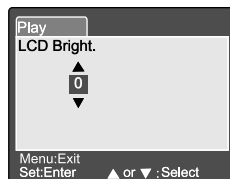

Adjust the brightness of the LCD monitor. This adjustment does not adjust the brightness of the image to be recorded. The LCD monitor's adjustment range is within -5 to +5.

1. Set the mode dial to [  ] and power on the camera.
2. Press the **MENU** button.
  - The menu screen appears.
3. Select the "LCD Bright." by using the ▲ or ▼ button and press the **SET** button.
4. Use the ▲ or ▼ button to select the desired setting and press the **SET** button.



## LCD Monitor Display (Playback Mode)

The [  ] Display button can switch the display on the LCD monitor when playing back photographed images. You can switch the display to show a list of detailed information.

1. Set the mode dial to [  ] and power on the camera.
2. Rotate the **Command** dial or press ▲ or ▼ button to select the image.
3. Press the [  ] button.
  - Each press of the [  ] button switches the display format as follows:  
Standard → Image only → Detailed information

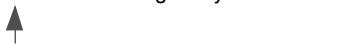







### Note:

- This function is not available for movie image playback.



## ERASING IMAGES [ ]

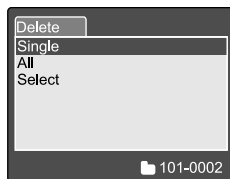

The [  ] button provides to erase image file. While pressing [  ] button during monitoring mode, the latest image data and erase menu appears on the LCD monitor.

1. Set the mode dial to [  ] and power on the camera.
2. Press the [  ] button.
  - The Delete menu is displayed on the LCD monitor.
3. Use the  or  button to select the Delete sub-menu (Single/All/Select).



### Erasing Single Image

Single: Erase this image.

- a. Select [**Single**] and press the **SET** button to confirm the selection.
  - "Delete This Picture?" sub-menu is displayed on the LCD monitor.
- b. Use the  or  button to select Execute/Cancel.

[**Execute**]: Erase this image.

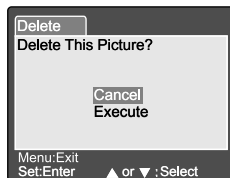

[**Cancel**]: Cancel the deletion

- c. Press the **SET** button to confirm the setting.



### Erasing All Images

All: Erase all images.

- a. Select [**All**] and press the **SET** button to confirm the selection.
  - "Delete All Pictures?" sub-menu is displayed on the LCD monitor.
- b. Use the  or  button to select Execute/Cancel.
 

[**Execute**]: Erase this image.



[**Cancel**]: Cancel the deletion.

- c. Press the **SET** button to confirm the setting.



## Erasing Selected Image

Select: Erase the selected image.

- a. Select **[Select]** and press the **SET** button to confirm the selection.
  - Thumbnail display and [  ] appear on the LCD monitor.
- b. Use the **▲**, **▼**, **◀** or **▶** button to select the image you want to erase and press the [  ] button to confirm the selection.
  - [  ] icon appears on the selected image.
- c. Press the **SET** button to confirm deletion.



### **Note:**

- Images cannot be erased when they are protected or the SD Memory Card is write-protected.
- This function is available for all modes except for PC and SET-UP modes

## SET-UP MODE

This feature allows you to set up the default settings for using your camera in addition to image-related settings. You can select your personal preferences for the camera by this mode.

### Basic Setting

The Basic Setting contains 6 items:  
Card Information, Frame Number Reset, Format, Sound, Beep and Auto Power Off.

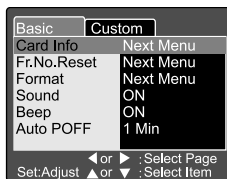

### Card Information

Display the total and remaining memory size of the inserted SD Memory Card.

1. Set the mode dial to **[SET-UP]** and power on the camera.
2. Use the **▲** or **▼** button to select Card Info.
3. Press the **SET** button.
  - Card Information will be displayed.
4. Press **SET** button once again to exit.

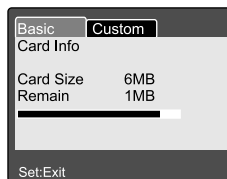

## Frame Number Reset

Reset the frame number.

Default reset: Folder number is 100 and file number is 0001.

1. Set the mode dial to **[SET-UP]** and power on the camera.
2. Use the **▲** or **▼** button to select Fr. No. Reset.
3. Press the **SET** button.
  - Frame Number Reset menu is displayed on the LCD monitor.
4. Use the **▲** or **▼** button to select Execute/Cancel.
 

**[Execute]:** Reset the frame number.

**[Cancel]:** Does not reset the frame number.
5. Press the **SET** button to confirm the setting.

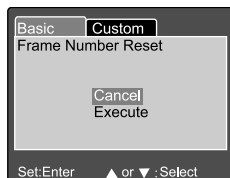

### Note:

- If folder already exists on SD Memory Card, it assigns older number than the existing folder.

## Format

Formatting erases all images and reformats the SD Memory Card loaded in your camera. Protected images are also erased. SD Memory Card cannot be formatted if it is write-protected.

1. Set the mode dial to **[SET-UP]** and power on the camera.
2. Use the **▲** or **▼** button to select Format.
3. Press the **SET** button.
  - "Format SD card" menu is displayed on the LCD monitor.
4. Use the **▲** or **▼** button to select Execute/Cancel.
 

**[Execute]:** Format the memory card.

**[Cancel]:** Does not format the memory card.
5. Press the **SET** button to confirm the setting.

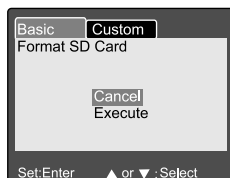

## Sound

Set the sound ON/OFF.

1. Set the mode dial to **[SET-UP]** and power on the camera.
2. Use the ▲ or ▼ button to select Sound.
3. Press the **SET** button.
  - The pull down menu for Sound is displayed on the LCD monitor.
4. Use the ▲ or ▼ button to select the desired sound setting.
  - [ON]**: Enable the sound setting.
  - [OFF]**: Disable the sound setting.
5. Press the **SET** button to confirm the setting.

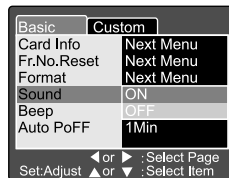

## Beep

Set the beep ON/OFF.

1. Set the mode dial to **[SET-UP]** and power on the camera,
2. Use the ▲ or ▼ button to select Beep.
3. Press the **SET** button.
  - The pull down menu for Beep is displayed on the LCD monitor.
4. Use the ▲ or ▼ button to select ON/OFF.
  - [ON]** : Enable the beep setting.
  - [OFF]** : Disable the beep setting.
5. Press the **SET** button to confirming the setting.

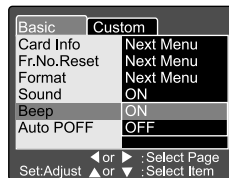

## Auto Power Off

In case no buttons is pressed for a certain period of time while power on, the camera turns off automatically to conserve power. The default value is 1 minute.

1. Set the mode dial to **[SET-UP]** and power on the camera.
2. Use the **▲** or **▼** button to select Auto PoFF.
3. Press the **SET** button.
  - The pull down menu for Auto Power Off is displayed on the LCD monitor.
3. Use the **▲** or **▼** button to select the desired time setting.

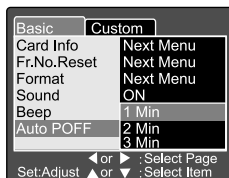

**[1 Min]:** If no operation is carried out for 1 minute, Auto power off is activated (default).

**[2 Min]:** If no operation is carried out for 2 minutes, Auto power off is activated.

**[3 Min]:** If no operation is carried out for 3 minutes, Auto power off is activated.

4. Press the **SET** button to confirm the setting.

## Custom Setting

The Custom Setting contains 5 items: Date/Time, System Reset, Language, Video Output and System Information.

### Date/Time

Set the Date and Time.

1. Set the mode dial to **[SET-UP]** and power on the camera.
2. Use the **▲** or **▼** button to select Date/Time.
3. Press the **SET** button.
  - The Date/Time menu is displayed on the LCD monitor.
4. Use the **◀** or **▶** button to select the item to set.
5. Use the **▲** or **▼** button to set the value for each item.
6. Press the **SET** button to confirm the setting after all item values are set.

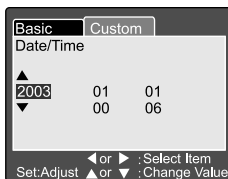
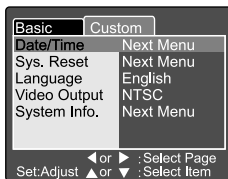

### System Reset

Set all the parameter to default settings.

1. Set the mode dial to **[SET-UP]** and power on the camera.
2. Use the **▲** or **▼** button to select System Reset.
3. Press the **SET** button.
  - The System Reset menu is displayed on the LCD monitor.
4. Use the **▲** or **▼** button to select Execute/Cancel.
  - [Execute]:** Return to default setting.
  - [Cancel]:** Retain the current setting.
5. Press the **SET** button to confirm the setting.



### Note:

- Date/Time cannot be reset.

## Language

Set the on-screen display language.

1. Set the mode dial to **[SET-UP]** and power on the camera.
2. Use the **▲** or **▼** button to select Language.
3. Press the **SET** button.
  - The pull down menu for Language is displayed on the LCD monitor.
4. Use the **▲** or **▼** button to select the desired OSD language.
5. Press the **SET** button to confirm the setting.

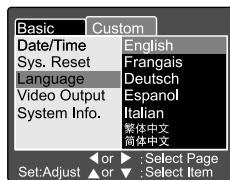

## Video Output

Set the video output system according to the country in which your camera used.

1. Set the mode dial to **[SET-UP]** and power on the camera.
2. Use the **▲** or **▼** button to select Video Output.
3. Press the **SET** button.
  - The pull down menu for Video Output is displayed on the LCD monitor.
4. Use the **▲** or **▼** button to select the desired setting.
  - [NTSC]** : NTSC system.
  - [PAL]** : PAL system.
5. Press the **SET** button to confirm the setting.

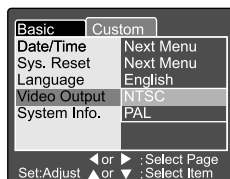



## System Information

Display the camera firmware version.

1. Set the mode dial to **[SET-UP]** and power on the camera.
2. Use the ▲ or ▼ button to select System Info.
3. Press the **SET** button.
  - The camera firmware version is displayed on the LCD monitor.
4. To return to main menu, press the **SET** button.

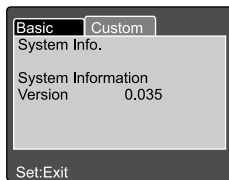

## TRANSFERRING RECORDED IMAGES/ MOVIES TO YOUR COMPUTER

You can share recorded images/movies with your family or friends via e-mail or post them on the Web. Before doing those things, you need to connect the camera to your computer by using the USB cable and then transfer the images/movies.

To transfer images/movies from the camera to your computer, follow these steps:

**Step 1: Installing the USB driver**

**Step 2: Connecting the camera to your computer**

**Step 3: Downloading images/movies**

	<b>System Requirements (Windows)</b>	<b>System Requirements (Macintosh)</b>
CPU	Pentium 166 MHz processor or higher	PowerPC G3/G4
OS	Windows 98/98SE/Me/2000/XP	OS 8.6 or higher
Memory	32MB (64MB RAM recommended)	32MB (64MB RAM recommended)
Free Space on Hard Disk	128 MB hard disk space	128 MB hard disk space
Required Devices	A CD-ROM Drive, An Available USB Port	A CD-ROM Drive, An Available USB Port
Color Monitor	Color Monitor (800x600, 24-bit or higher recommended)	Color Monitor (800x600, 24-bit or higher recommended)

### Step 1: Installing the USB Driver

The USB driver on the CD-ROM is exclusively for Windows 98 and Mac OS 8.6 computers. For all later versions of Windows or MAC no driver is needed.

1. Insert the CD-ROM that came with the camera into your CD-ROM drive.
2. Follow the on-screen instructions to complete the installation.
3. After the USB driver has been installed, restart your computer.



### Step 2: Connecting the Camera to Your Computer

1. Set the mode dial to **PC** mode.
2. Connect one end of the USB cable to an available USB port on your computer.
3. Connect the other end of the USB cable to the USB connector on the camera.
4. Turn the camera on.
5. From the Windows desktop double click on "My Computer".

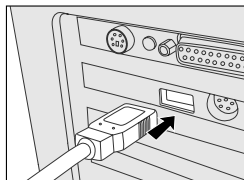

Look for a new "removable disk" icon appearing in the "My Computer" window. Your recorded images/movies will be in a folder on this "removable disk". (For Mac users, double-click the "untitled" disk drive on the desktop.)

### Step 3: Downloading Images/Movies

When the camera is turned on and connected to your computer, it is considered to be a disk drive, just like a floppy disk or CD. You can download (transfer) images by copying them from the "removable disk" ("untitled" disk on a Macintosh) to your computer hard drive.

### **Windows**

Open the “removable disk” by double clicking on it. Double click on the folder. Your images are inside the folder(s). Select the images that you want, then choose “Copy” from the “Edit” menu. Open the destination location and choose “Paste” from the “Edit” menu. You may also drag and drop image files from the camera to a desired location.

### **Macintosh**

Open the “untitled” disk window and the hard disk or the destination location. Drag and drop from the camera disk to the desired destination.

### **Note:**

- Memory card users may prefer to use a memory card reader (highly recommended).

# INSTALLING PHOTOSUITE

## INSTALLING PHOTOSUITE

PhotoSuite is a very user-friendly image-editing program. With PhotoSuite, you can breezily retouch, compose and organize your images. It contains a variety of templates, such as photo frames, birthday cards, calendars and more. Get your images ready and go explore this amazing program.

To install PhotoSuite:

1. Insert the CD-ROM packaged with the camera into the CD-ROM drive. The welcome screen appears.
2. Click "Install PhotoSuite". Follow the on-screen instructions to complete the installation.



**Note:**

- For information on how to use PhotoSuite to edit and retouch your recorded images, please refer to its online help.
- For Windows 2000/XP users, make sure to install and use the PhotoSuite while logged in as a user with an Administrator account.

## INSTALLING PHOTOVISTA

PhotoVista is a very user-friendly image-editing program. With PhotoVista you can breezily retouch, compose and organize your images. It contains a variety of templates , such as photo frames, birthday cards, calendars and more. Get your images ready and go explore this amazing program.

To install PhotoVista:

1. Insert the CD-ROM packaged with the camera into the CD- ROM drive. The welcome screen appears.
2. Click “Install PhotoVista”. Follow the on-screen instructions to complete the installation.

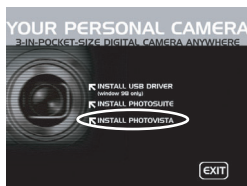

**Note:**

- For information on how to use PhotoVista to edit and retouch your recorded images, please refer to its online help.
- For Windows 2000/XP users, make sure to install and use the PhotoVista while logged in as a user with an Administrator account.

## CONNECTING THE CAMERA TO OTHER DEVICES

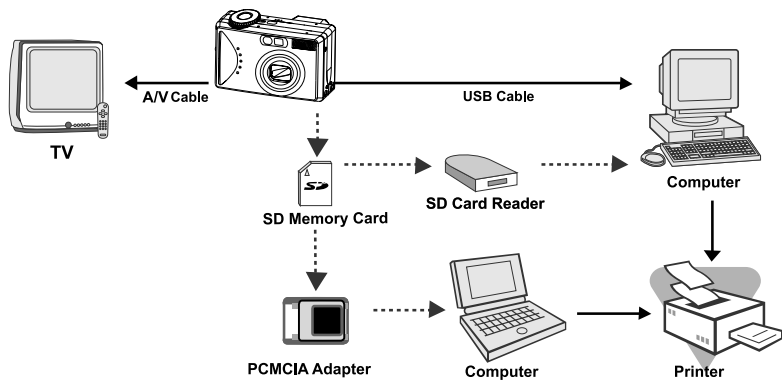

## CAMERA SPECIFICATIONS

Item	Description
Image sensor	1/1.8" CCD 5.25 megapixels
LCD monitor	1.5" full color TFT
Optical viewfinder	Real image viewfinder
Image quality	Fine/Standard/Economy
Image resolution	<Still image> 2560x1920, 2048x1536, 1280x960, 640x480 <Movie image> 320x240, 160x120
Image storage	SD Memory Card (up to 512MB)
Image file format	DCF, DPOF, EXIF
Lens	f = 7.2mm~21.6mm F=2.8~4.7
Focus range	0.30m ~infinity (Macro Tele) 0.09m~infinity (Macro Wide) 0.80m~infinity (Standard)
Focusing	Auto-focus
Shutter speed	8sec~1/1500 sec
Image capturing	Single/Continuous/Auto exposure
Digital zoom	4x (Capture mode) 2x and 4x (Playback mode)
Exposure	Program/Tv/Av/Manual/Portrait/Sports/Night scene
Exposure compensation	-2EV~+2EV
White balance	Auto/Incandescent/Fluorescent 1/ Fluorescent 2/ Day light/Cloudy/Manual
Flash	Auto/Red-eye forced flash/ Suppressed flash/ Forced flash
Flash effective range	0.5m~3.0m
ISO sensitivity	100~400 (Auto) 100/100-200/100-400 (Except Auto)
Self-timer	10 sec/2sec/10+2 sec/Interval
Video output	640x480 (Playback mode) NTSC/PAL
Terminal	DC IN terminal/USB terminal/A/V OUT terminal
Power supply	Lithium Ion battery or AC adapter (5V)
Dimension (WxDxH)	94x63x35mm (without protruding parts)
Weight	Approx. 180g (without battery)

\*Design and specifications are subject to change without notice.